

DDR2 SDRAM RDIMM

MT72HT(Z)S1G72P – 8GB

For the latest component data sheets, refer to Micron's Web site: www.micron.com

Features

- 240-pin, registered dual in-line memory module (RDIMM)
- Quad rank, using 36 TwinDie™ DRAM devices
- Fast data transfer rates: PC2-3200, PC2-4200, or PC2-5300
- 8GB (1 Gig x 72)
- Supports ECC error detection and correction
- VDD = VDDQ = +1.8V
- VDDSPD = +1.7V to +3.6V
- JEDEC-standard 1.8V I/O (SSTL_18-compatible)
- Differential data strobe (DQS, DQS#) option
- 4n-bit prefetch architecture
- Multiple internal device banks for concurrent operation
- Programmable CAS# latency (CL)
- Posted CAS# additive latency (AL)
- WRITE latency = READ latency - 1 t_{CK}
- Programmable burst lengths (BL) 4 or 8
- Adjustable data-output drive strength
- 64ms, 8,192-cycle refresh
- On-die termination (ODT)
- Register parity
- Serial presence-detect (SPD) with EEPROM
- Gold edge contacts

Figure 1: 240-Pin RDIMM (MO-237 R/C M)

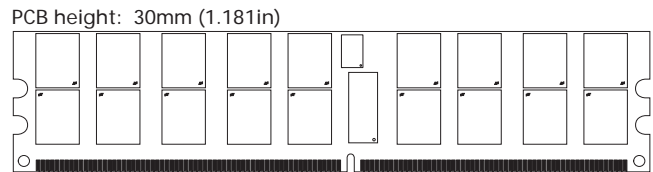

Options

- Heat spreader
- Operating temperature¹
 - Commercial (0°C ≤ T_A ≤ +70°C)
 - Industrial (-40°C ≤ T_A ≤ +85°C)
- Package
 - 240-pin DIMM (Pb-free)
- Frequency/CAS latency²
 - 3.0ns @ CL = 5 (DDR2-667)
 - 3.75ns @ CL = 4 (DDR2-533)
 - 5.0ns @ CL = 3 (DDR2-400)³

Marking

- Z
- None
- I
- Y
- 667
- 53E
- 40E

- Notes: 1. Contact Micron for industrial temperature module offerings.
 2. CL = CAS (READ) latency; registered mode will add one clock cycle to CL.
 3. Not recommended for new designs.

Table 1: Key Timing Parameters

Speed Grade	Industry Nomenclature	Data Rate (MT/s)			t _{RCD} (ns)	t _{RP} (ns)	t _{RC} (ns)
		CL = 5	CL = 4	CL = 3			
-667	PC2-5300	667	533	400	15	15	55
-53E	PC2-4200	–	533	400	15	15	55
-40E	PC2-3200	–	400	400	15	15	55



Table 2: Addressing

Parameter	8GB
Refresh count	8K
Row address	32K (A0–A13)
Device bank address	8 (BA0–BA2)
Device page size per bank	1KB
Device configuration	2Gb TwinDie™ (512 Meg x 4)
Column address	2K (A0–A9, A11)
Module rank address	4 (S0#–S3#)

Table 3: Part Numbers and Timing Parameters – 8GB Modules

Base device: MT47H512M4THN,¹ 2Gb TwinDie™ DDR2 SDRAM

Part Number ²	Module Density	Configuration	Module Bandwidth	Memory Clock/ Data Rate	Clock Cycles (CL- ^t RCD- ^t RP)
MT72HTS1G72PY-667__	8GB	1 Gig x 72	5.3 GB/s	3.0ns/667 MT/s	5-5-5
MT72HTS1G72PY-53E__	8GB	1 Gig x 72	4.3 GB/s	3.75ns/533 MT/s	4-4-4
MT72HTS1G72PY-40E__	8GB	1 Gig x 72	3.2 GB/s	5.0ns/400 MT/s	3-3-3
MT72HTZS1G72PY-667__	8GB	1 Gig x 72	5.3 GB/s	3.0ns/667 MT/s	5-5-5
MT72HTZS1G72PY-53E__	8GB	1 Gig x 72	4.3 GB/s	3.75ns/533 MT/s	4-4-4
MT72HTZS1G72PY-40E__	8GB	1 Gig x 72	3.2 GB/s	5.0ns/400 MT/s	3-3-3

- Notes:
1. Data sheets for the base device can be found on Micron's Web site.
 2. All part numbers end with a two-place code (not shown), designating component and PCB revisions. Consult factory for current revision codes. Example: MT72HTS1G72PY-667E1.



Pin Assignments and Descriptions

Table 4: Pin Assignments

240-Pin RDIMM Front								240-Pin RDIMM Back							
Pin	Symbol	Pin	Symbol	Pin	Symbol	Pin	Symbol	Pin	Symbol	Pin	Symbol	Pin	Symbol		
1	VREF	31	DQ19	61	A4	91	Vss	121	Vss	151	Vss	181	VDDQ	211	DQS14
2	Vss	32	Vss	62	VDDQ	92	DQS5#	122	DQ4	152	DQ28	182	A3	212	DQS14#
3	DQ0	33	DQ24	63	A2	93	DQS5	123	DQ5	153	DQ29	183	A1	213	Vss
4	DQ1	34	DQ25	64	VDD	94	Vss	124	Vss	154	Vss	184	VDD	214	DQ46
5	Vss	35	Vss	65	Vss	95	DQ42	125	DQS9	155	DQS12	185	CK0	215	DQ47
6	DQS0#	36	DQS3#	66	Vss	96	DQ43	126	DQS9#	156	DQS12#	186	CK0#	216	Vss
7	DQS0	37	DQS3	67	VDD	97	Vss	127	Vss	157	Vss	187	VDD	217	DQ52
8	Vss	38	Vss	68	PAR_IN	98	DQ48	128	DQ6	158	DQ30	188	A0	218	DQ53
9	DQ2	39	DQ26	69	VDD	99	DQ49	129	DQ7	159	DQ31	189	VDD	219	Vss
10	DQ3	40	DQ27	70	A10	100	Vss	130	Vss	160	Vss	190	BA1	220	S2#
11	Vss	41	Vss	71	BA0	101	SA2	131	DQ12	161	CB4	191	VDDQ	221	S3#
12	DQ8	42	CB0	72	VDDQ	102	NC	132	DQ13	162	CB5	192	RAS#	222	Vss
13	DQ9	43	CB1	73	WE#	103	Vss	133	Vss	163	Vss	193	SO#	223	DQS15
14	Vss	44	Vss	74	CAS#	104	DQS6#	134	DQS10	164	DQS17	194	VDDQ	224	DQS15#
15	DQS1#	45	DQS8#	75	VDDQ	105	DQS6	135	DQS10#	165	DQS17#	195	ODT0	225	Vss
16	DQS1	46	DQS8	76	S1#	106	Vss	136	Vss	166	Vss	196	A13	226	DQ54
17	Vss	47	Vss	77	ODT1	107	DQ50	137	RFU	167	CB6	197	VDD	227	DQ55
18	RESET#	48	CB2	78	VDDQ	108	DQ51	138	RFU	168	CB7	198	Vss	228	Vss
19	NC	49	CB3	79	Vss	109	Vss	139	Vss	169	Vss	199	DQ36	229	DQ60
20	Vss	50	Vss	80	DQ32	110	DQ56	140	DQ14	170	VDDQ	200	DQ37	230	DQ61
21	DQ10	51	VDDQ	81	DQ33	111	DQ57	141	DQ15	171	CKE1	201	Vss	231	Vss
22	DQ11	52	CKE0	82	Vss	112	Vss	142	Vss	172	VDD	202	DQS13	232	DQS16
23	Vss	53	VDD	83	DQS4#	113	DQS7#	143	DQ20	173	A15	203	DQS13#	233	DQS16#
24	DQ16	54	BA2	84	DQS4	114	DQS7	144	DQ21	174	A14	204	Vss	234	Vss
25	DQ17	55	ERR_OUT	85	Vss	115	Vss	145	Vss	175	VDDQ	205	DQ38	235	DQ62
26	Vss	56	VDDQ	86	DQ34	116	DQ58	146	DQS11	176	A12	206	DQ39	236	DQ63
27	DQS2#	57	A11	87	DQ35	117	DQ59	147	DQS11#	177	A9	207	Vss	237	Vss
28	DQS2	58	A7	88	Vss	118	Vss	148	Vss	178	VDD	208	DQ44	238	VDDSPD
29	Vss	59	VDD	89	DQ40	119	SDA	149	DQ22	179	A8	209	DQ45	239	SA0
30	DQ18	60	A5	90	DQ41	120	SCL	150	DQ23	180	A6	210	Vss	240	SA1

Table 5: Pin Descriptions

Symbol	Type	Description
A0–A15	Input (SSTL_18)	Address inputs: Provide the row address for ACTIVE commands, and the column address and auto precharge bit (A10) for READ/WRITE commands, to select one location out of the memory array in the respective bank. A10 sampled during a PRECHARGE command determines whether the PRECHARGE applies to one device bank (A10 LOW, device bank selected by BA0–BA2) or all device banks (A10 HIGH). The address inputs also provide the op-code during a LOAD MODE command. A0–A13 (8GB), A14, and A15 are connected for parity.
BA0–BA2	Input (SSTL_18)	Bank address inputs: BA0–BA2 define to which device bank an ACTIVE, READ, WRITE, or PRECHARGE command is being applied. BA0–BA2 define which mode register, including MR, EMR, EMR(2), and EMR(3), is loaded during the LOAD MODE command.
CK0, CK0#	Input (SSTL_18)	Clock: CK and CK# are differential clock inputs. All address and control input signals are sampled on the crossing of the positive edge of CK and the negative edge of CK#. Output data (DQs and DQS/DQS#) is referenced to the crossings of CK and CK#.
CKE0, CKE1	Input (SSTL_18)	Clock enable: CKE (registered HIGH) activates and CKE (registered LOW) deactivates clocking circuitry on the DDR2 SDRAM.
ODT0, ODT1	Input (SSTL_18)	On-die termination: ODT (registered HIGH) enables termination resistance internal to the DDR2 SDRAM. When enabled, ODT is only applied to the following pins: DQ, DQS, DQS#, and CB. The ODT input will be ignored if disabled via the LOAD MODE command.
PAR_IN	Input (SSTL_18)	Parity bit for the address and control bus.
RAS#, CAS#, WE#	Input (SSTL_18)	Command inputs: RAS#, CAS#, and WE# (along with S#) define the command being entered.
RESET#	Input (LVCMOS)	Asynchronously forces all registered outputs LOW when RESET# is LOW. This signal can be used during power-up to ensure that CKE is LOW and DQs are High-Z.
S0#–S3#	Input (SSTL_18)	Chip select: S# enables (registered LOW) and disables (registered HIGH) the command decoder.
SA0–SA2	Input (SSTL_18)	Presence-detect address inputs: These pins are used to configure the presence-detect devices.
SCL	Input (SSTL_18)	Serial clock for presence-detect: SCL is used to synchronize the presence-detect data transfer to and from the module.
CB0–CB7	I/O (SSTL_18)	Check bits.
DQ0–DQ63	I/O (SSTL_18)	Data input/output: Bidirectional data bus.
DQS0–DQS17, DQS0#–DQS17#	I/O (SSTL_18)	Data strobe: Output with read data, input with write data for source synchronous operation. Edge-aligned with read data, center-aligned with write data. DQS# is only used when differential data strobe mode is enabled via the LOAD MODE command.
SDA	I/O (SSTL_18)	Serial presence-detect data: SDA is a bidirectional pin used to transfer addresses and data into and out of the presence-detect portion of the module.
ERR_OUT	Output (open drain)	Parity error found on the address and control bus.
VDD/VDDQ	Supply	Power supply: 1.8V ±0.1V.
VDDSPD	Supply	Serial EEPROM positive power supply: +1.7V to +3.6V.
VREF	Supply	SSTL_18 reference voltage VDD/2.
VSS	Supply	Ground.
NC	–	No connect: These pins should be left unconnected.
RFU	–	Reserved for future use.

Functional Block Diagram

Figure 2: Functional Block Diagram

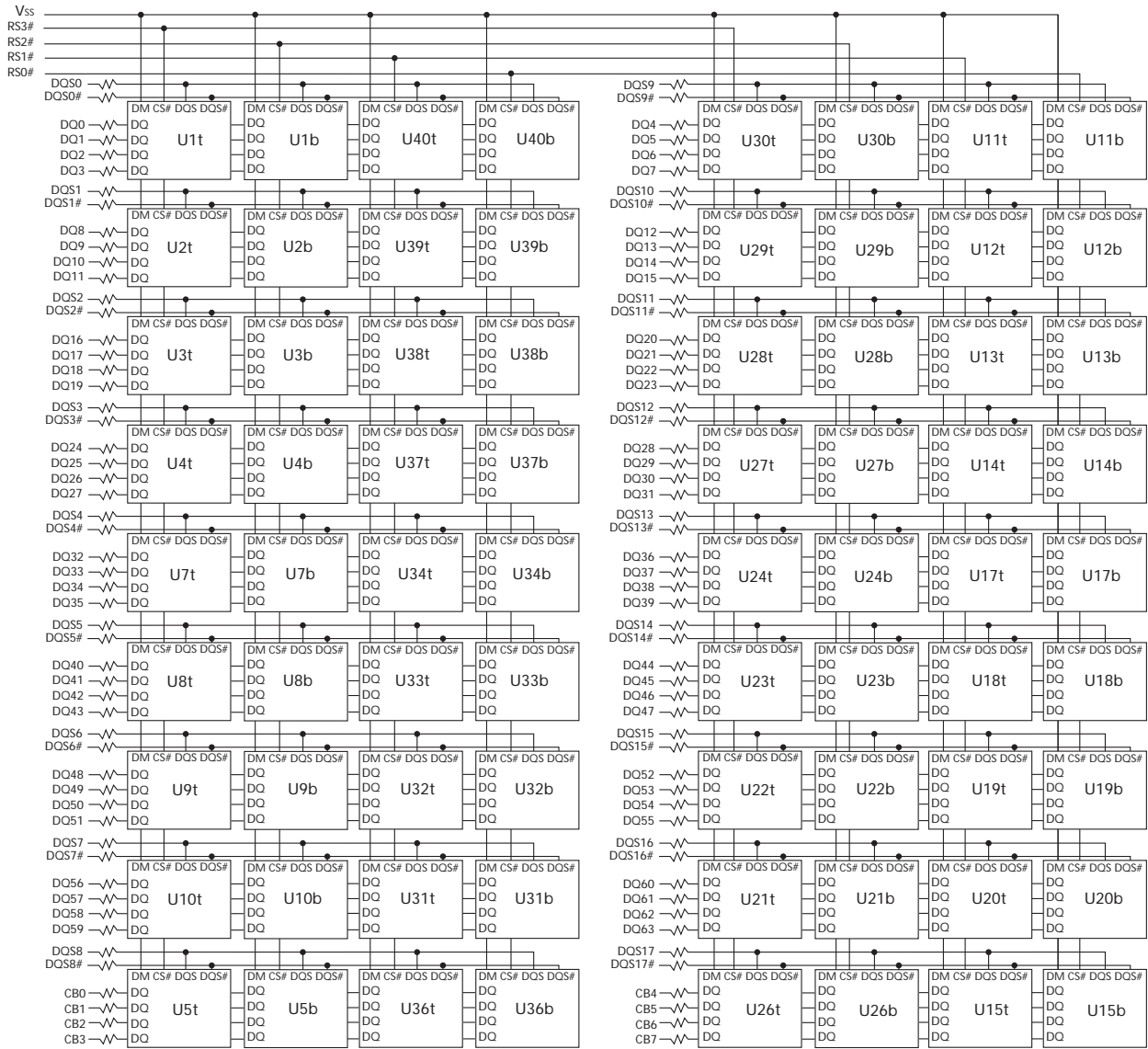

Rank 0 = U11b-U15b, U17b-U20b, U31b-U34b, U36b-U40b
 Rank 1 = U11t-U15t, U17t-U20t, U31t-U34t, U36t-U40t
 Rank 2 = U1b-U5b, U7b-U10b, U21b-U24b, U26b-U30b
 Rank 3 = U1t-U5t, U7t-U10t, U21t-U24t, U26t-U30t

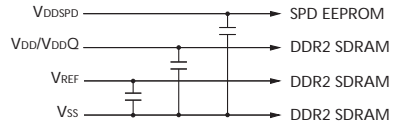
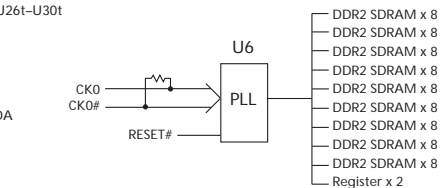
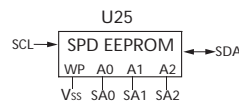
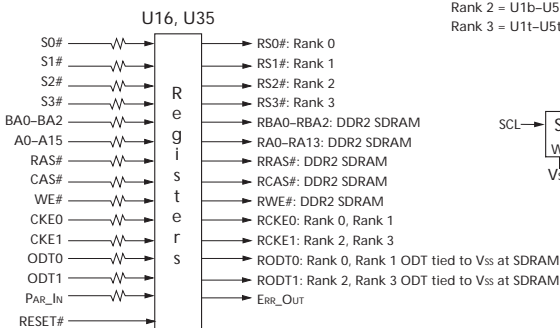

General Description

The MT72HT(Z)S1G72P DDR2 SDRAM module is a high-speed, CMOS, dynamic random access 8GB memory module organized in a x72 configuration. This DDR2 SDRAM module uses internally configured, 8-bank, 2Gb TwinDie™ DDR2 SDRAM devices.

DDR2 SDRAM modules use double data rate architecture to achieve high-speed operation. The double data rate architecture is essentially a $4n$ -prefetch architecture with an interface designed to transfer two data words per clock cycle at the I/O pins. A single read or write access for the DDR2 SDRAM module effectively consists of a single $4n$ -bit-wide, one-clock-cycle data transfer at the internal DRAM core and four corresponding n -bit-wide, one-half-clock-cycle data transfers at the I/O pins.

A bidirectional data strobe (DQS, DQS#) is transmitted externally, along with data, for use in data capture at the receiver. DQS is a strobe transmitted by the DDR2 SDRAM device during READs and by the memory controller during WRITEs. DQS is edge-aligned with data for READs and center-aligned with data for WRITEs.

DDR2 SDRAM modules operate from a differential clock (CK and CK#); the crossing of CK going HIGH and CK# going LOW will be referred to as the positive edge of CK. Commands are registered at every positive edge of CK. Input data is registered on both edges of DQS, and output data is referenced to both edges of DQS, as well as to both edges of CK.

Register and PLL Operations

DDR2 SDRAM modules operate in registered mode, where the command/address input signals are latched in the registers on the rising clock edge and sent to the DDR2 SDRAM devices on the following rising clock edge (data access is delayed by one clock cycle). A phase-lock loop (PLL) on the module receives and redrives the differential clock signals (CK, CK#) to the DDR2 SDRAM devices. The register(s) and PLL reduce address, command, control, and clock signal loading by isolating the memory devices from the system controller. PLL clock timing is defined by JEDEC specifications and ensured by use of the JEDEC clock reference board. Registered mode will add one clock cycle to CL.

Parity Option

If provided from the system memory controller, (PAR_IN) is compared within the register to the command and address inputs of the register. An even number of ones among these inputs is defined as valid parity. In the case that invalid parity is detected, ERR_OUT will be set LOW.

Serial Presence-Detect Operation

DDR2 SDRAM modules incorporate serial presence-detect (SPD). The SPD function is implemented using a 2,048-bit EEPROM. This nonvolatile storage device contains 256 bytes. The first 128 bytes are programmed by Micron to identify the module type and various SDRAM organizations and timing parameters. The remaining 128 bytes of storage are available for use by the customer. System READ/WRITE operations between the master (system logic) and the slave EEPROM device occur via a standard I²C bus using the DIMM's SCL (clock) and SDA (data) signals, together with SA (2:0), which provide eight unique DIMM/EEPROM addresses. Write protect (WP) is tied to VSS on the module, permanently disabling hardware write protect.

Electrical Specifications

Stresses greater than those listed in Table 6 may cause permanent damage to the module. This is a stress rating only, and functional operation of the module at these or any other conditions outside those indicated in each device's data sheet is not implied. Exposure to absolute maximum rating conditions for extended periods may adversely affect reliability.

Table 6: Absolute Maximum Ratings

Symbol	Parameter	Min	Max	Units	
VDD/VDDQ	VDD/VDDQ supply voltage relative to Vss	-0.5	+2.3	V	
VIN, VOUT	Voltage on any pin relative to Vss	-0.5	+2.3	V	
II	Input leakage current; Any input $0V \leq V_{IN} \leq V_{DD}$; VREF input $0V \leq V_{IN} \leq 0.95V$ (All other pins not under test = 0V)	Address inputs RAS#, CAS#, WE#, S#, CKE, ODT, BA	-10	+10	μA
		CK, CK#	-250	+250	
IOZ	Output leakage current; $0V \leq V_{OUT} \leq V_{DDQ}$; DQs and ODT are disabled	-20	+20	μA	
IVREF	VREF leakage current; VREF = valid VREF level	-144	+144	μA	
TA	Module ambient operating temperature	Commercial	0	+70	$^{\circ}C$
		Industrial	-40	+85	$^{\circ}C$
TC ¹	DDR2 SDRAM component case operating temperature ²	Commercial	0	+85	$^{\circ}C$
		Industrial	-40	+95	$^{\circ}C$

- Notes: 1. The refresh rate is required to double when $85^{\circ}C < T_C \leq 95^{\circ}C$.
2. For further information, refer to technical note TN-00-08: Thermal Applications, available on Micron's Web site.

Input Capacitance

Micron encourages designers to simulate the performance of the module to achieve optimum values. Simulations are significantly more accurate and realistic than a gross estimation of module capacitance when inductance and delay parameters associated with trace lengths are used in simulations. JEDEC modules are currently designed using simulations to close timing budgets.

Component Timing and Operating Conditions

Recommended AC operating conditions are given in the DDR2 component data sheets. Component specifications are available on Micron's Web site. Module speed grades correlate with component speed grades as shown in Table 7.

Table 7: Module and Component Speed Grades

Module Speed Grade	Component Speed Grade
-667	-3
-53E	-37E
-40E	-5E

IDD Specifications

Table 8: DDR2 IDD Specifications and Conditions – 8GB

Values are shown for the MT47H512M4THN DDR2 SDRAM only and are computed from values specified in the MT47H256M4 2Gb TwinDie™ component data sheet

Parameter/Condition	Symbol	-667	-53E	-40E	Units	
Operating one bank active-precharge current: $t_{CK} = t_{CK} (I_{DD})$, $t_{RC} = t_{RC} (I_{DD})$, $t_{RAS} = t_{RAS} \text{ MIN} (I_{DD})$; CKE is HIGH, S# is HIGH between valid commands; Address bus inputs are switching; Data bus inputs are switching	ICDD0	2,592	2,322	2,232	mA	
Operating one bank active-read-precharge current: $I_{OUT} = 0\text{mA}$; BL = 4, CL = CL (IDD), AL = 0; $t_{CK} = t_{CK} (I_{DD})$, $t_{RC} = t_{RC} (I_{DD})$, $t_{RAS} = t_{RAS} \text{ MIN} (I_{DD})$, $t_{RCD} = t_{RCD} (I_{DD})$; CKE is HIGH, S# is HIGH between valid commands; Address bus inputs are switching; Data pattern is same as IDD4W	ICDD1	2,862	2,772	2,592	mA	
Precharge power-down current: All device banks idle; $t_{CK} = t_{CK} (I_{DD})$; CKE is LOW; Other control and address bus inputs are stable; Data bus inputs are floating	ICDD2P	594	594	594	mA	
Precharge quiet standby current: All device banks idle; $t_{CK} = t_{CK} (I_{DD})$; CKE is HIGH, S# is HIGH; Other control and address bus inputs are stable; Data bus inputs are floating	ICDD2Q	1,782	1,782	1,602	mA	
Precharge standby current: All device banks idle; $t_{CK} = t_{CK} (I_{DD})$; CKE is HIGH, S# is HIGH; Other control and address bus inputs are switching; Data bus inputs are switching	ICDD2N	1,782	1,782	1,602	mA	
Active power-down current: All device banks open; $t_{CK} = t_{CK} (I_{DD})$; CKE is LOW; Other control and address bus inputs are stable; Data bus inputs are floating	ICDD3P	Fast PDN exit MR[12] = 0	1,008	1,008	1,008	mA
		Slow PDN exit MR[12] = 1	648	648	648	mA
Active standby current: All device banks open; $t_{CK} = t_{CK} (I_{DD})$, $t_{RAS} = t_{RAS} \text{ MAX} (I_{DD})$, $t_{RP} = t_{RP} (I_{DD})$; CKE is HIGH, S# is HIGH between valid commands; Other control and address bus inputs are switching; Data bus inputs are switching	ICDD3N	2,052	1,872	1,692	mA	
Operating burst write current: All device banks open; Continuous burst writes; BL = 4, CL = CL (IDD), AL = 0; $t_{CK} = t_{CK} (I_{DD})$, $t_{RAS} = t_{RAS} \text{ MAX} (I_{DD})$, $t_{RP} = t_{RP} (I_{DD})$; CKE is HIGH, S# is HIGH between valid commands; Address bus inputs are switching; Data bus inputs are switching	ICDD4W	3,222	3,042	2,592	mA	
Operating burst read current: All device banks open; Continuous burst reads; $I_{OUT} = 0\text{mA}$; BL = 4, CL = CL (IDD), AL = 0; $t_{CK} = t_{CK} (I_{DD})$, $t_{RAS} = t_{RAS} \text{ MAX} (I_{DD})$, $t_{RP} = t_{RP} (I_{DD})$; CKE is HIGH, S# is HIGH between valid commands; Address bus inputs are switching; Data bus inputs are switching	ICDD4R	3,222	3,042	2,592	mA	
Burst refresh current: $t_{CK} = t_{CK} (I_{DD})$; REFRESH command at every $t_{RFC} (I_{DD})$ interval; CKE is HIGH, S# is HIGH between valid commands; Other control and address bus inputs are switching; Data bus inputs are switching	ICDD5	4,932	4,842	4,662	mA	
Self refresh current: CK and CK# at 0V; CKE $\leq 0.2\text{V}$; Other control and address bus inputs are floating; Data bus inputs are floating	ICDD6	594	594	594	mA	
Operating bank interleave read current: All device banks interleaving reads; $I_{OUT} = 0\text{mA}$; BL = 4, CL = CL (IDD), AL = $t_{RCD} (I_{DD}) - 1 \times t_{CK} (I_{DD})$; $t_{CK} = t_{CK} (I_{DD})$, $t_{RC} = t_{RC} (I_{DD})$, $t_{RRD} = t_{RRD} (I_{DD})$, $t_{RCD} = t_{RCD} (I_{DD})$; CKE is HIGH, S# is HIGH between valid commands; Address bus inputs are stable during deselects; Data bus inputs are switching	ICDD7	6,102	5,922	5,652	mA	

Register and PLL Specifications

Table 9: Register Specifications
SSTU32868 devices or equivalent JESD82-14

Parameter	Symbol	Pins	Condition	Min	Max	Units
DC high-level input voltage	V _{IH(DC)}	Address, control, command	SSTL_18	V _{REF(DC)} + 125	V _{DDQ} + 250	mV
DC low-level input voltage	V _{IL(DC)}	Address, control, command	SSTL_18	0	V _{REF(DC)} - 125	mV
AC high-level input voltage	V _{IH(AC)}	Address, control, command	SSTL_18	V _{REF(DC)} + 250	V _{DD}	mV
AC low-level input voltage	V _{IL(AC)}	Address, control, command	SSTL_18	0	V _{REF(DC)} - 250	mV
Output high voltage	V _{OH}	Parity output	LVC MOS	1.2	–	V
Output low voltage	V _{OL}	Parity output	LVC MOS	–	0.5	V
Input current	I _I	All pins	V _I = V _{DDQ} or V _{SSQ}	–5	5	μA
Static standby	I _{DD}	All pins	RESET# = V _{SSQ} (I _O = 0)	–	100	μA
Static operating	I _{DD}	All pins	RESET# = V _{SSQ} ; V _I = V _{IH(AC)} or V _{IL(DC)} I _O = 0	–	80	mA
Dynamic operating (clock tree)	I _{DDD}	n/a	RESET# = V _{DD} , V _I = V _{IH(AC)} or V _{IL(AC)} , I _O = 0; CK and CK# switching 50 percent duty cycle	–	Varies by manufacturer	μA
Dynamic operating (per each input)	I _{DDD}	n/a	RESET# = V _{DD} , V _I = V _{IH(AC)} or V _{IL(AC)} , I _O = 0; CK and CK# switching 50 percent duty cycle; One data input switching at ^t CK/2, 50 percent duty cycle	–	Varies by manufacturer	μA
Input capacitance (per device, per pin)	C _I	All inputs except RESET#	V _I = V _{REF} ±250mV; V _{DDQ} = 1.8V	2.5	4	pF
Input capacitance (per device, per pin)	C _I	RESET#	V _I = V _{DDQ} or V _{SSQ}	–	Varies by manufacturer	pF

- Notes: 1. Timing and switching specifications for the register listed above are critical for proper operation of the DDR2 SDRAM registered DIMMs. These are meant to be a subset of the parameters for the specific device used on the module. Detailed information for this register is available in JEDEC standard JESD82.

Table 10: PLL Specifications
CU877 device or equivalent JESD82-8.01

Parameter	Symbol	Pins	Condition	Min	Max	Units
DC high-level input voltage	V _{IH}	RESET#	LVC MOS	0.65 × V _{DD}	–	V
DC low-level input voltage	V _{IL}	RESET#	LVC MOS	–	0.35 × V _{DD}	V
Input voltage (limits)	V _{IN}	RESET#, CK, CK#	–	–0.3	V _{DDQ} + 0.3	V
DC high-level input voltage	V _{IH}	CK, CK#	Differential input	0.65 × V _{DD}	–	V
DC low-level input voltage	V _{IL}	CK, CK#	Differential input	–	0.35 × V _{DD}	V
Input differential-pair cross voltage	V _{IX}	CK, CK#	Differential input	(V _{DDQ} /2) - 0.15	(V _{DDQ} /2) + 0.15	V
Input differential voltage	V _{ID(DC)}	CK, CK#	Differential input	0.3	V _{DDQ} + 0.4	V
Input differential voltage	V _{ID(AC)}	CK, CK#	Differential input	0.6	V _{DDQ} + 0.4	V
Input current	I _I	RESET#	V _I = V _{DDQ} or V _{SSQ}	–10	10	μA
		CK, CK#	V _I = V _{DDQ} or V _{SSQ}	–250	250	μA
Output disabled current	I _{ODL}	–	RESET# = V _{SSQ} ; V _I = V _{IH(AC)} or V _{IL(DC)}	100	–	μA
Static supply current	I _{DDLD}	–	CK = CK# = LOW	–	500	μA
Dynamic supply	I _{DD}	n/a	CK, CK# = 270 MHz, all outputs open (not connected to PCB)	–	300	mA
Input capacitance	C _{IN}	Each input	V _I = V _{DDQ} or V _{SSQ}	2	3	pF

Table 11: PLL Clock Driver Timing Requirements and Switching Characteristics

Parameter	Symbol	Min	Max	Units
Stabilization time	t _L	–	15	μs
Input clock slew rate	slr(i)	1	4	V/ns
SSC modulation frequency	–	30	33	kHz
SSC clock input frequency deviation	–	0	–0.5	%
PLL loop bandwidth (–3dB from unity gain)	–	2	–	MHz

Notes: 1. PLL timing and switching specifications are critical for proper operation of the DDR2 DIMM. This is a subset of parameters for the specific PLL used. Detailed PLL information is available in JEDEC standard JESD82-08.1.

Serial Presence-Detect

Table 12: Serial Presence-Detect EEPROM DC Operating Conditions

Parameter/Condition	Symbol	Min	Max	Units
Supply voltage	V _{DDSPD}	1.7	3.6	V
Input high voltage: Logic 1; All inputs	V _{IH}	V _{DDSPD} × 0.7	V _{DDSPD} + 0.5	V
Input low voltage: Logic 0; All inputs	V _{IL}	-0.6	V _{DDSPD} × 0.3	V
Output low voltage: I _{OUT} = 3mA	V _{OL}	-	0.4	V
Input leakage current: V _{IN} = GND to V _{DD}	I _{LI}	0.1	3	μA
Output leakage current: V _{OUT} = GND to V _{DD}	I _{LO}	0.05	3	μA
Standby current	I _{SB}	1.6	4	μA
Power supply current, READ: SCL clock frequency = 100 kHz	I _{CCR}	0.4	1	mA
Power supply current, WRITE: SCL clock frequency = 100 kHz	I _{CCW}	2	3	mA

Table 13: Serial Presence-Detect EEPROM AC Operating Conditions

Parameter/Condition	Symbol	Min	Max	Units	Notes
SCL LOW to SDA data-out valid	t _{AA}	0.2	0.9	μs	1
Time the bus must be free before a new transition can start	t _{BUF}	1.3	-	μs	
Data-out hold time	t _{DH}	200	-	ns	
SDA and SCL fall time	t _F	-	300	ns	2
Data-in hold time	t _{HD:DAT}	0	-	μs	
Start condition hold time	t _{HD:STA}	0.6	-	μs	
Clock HIGH period	t _{HIGH}	0.6	-	μs	
Noise suppression time constant at SCL, SDA inputs	t _I	-	50	ns	
Clock LOW period	t _{LOW}	1.3	-	μs	
SDA and SCL rise time	t _R	-	0.3	μs	2
SCL clock frequency	f _{SCL}	-	400	kHz	
Data-in setup time	t _{SU:DAT}	100	-	ns	
Start condition setup time	t _{SU:STA}	0.6	-	μs	3
Stop condition setup time	t _{SU:STO}	0.6	-	μs	
WRITE cycle time	t _{WRC}	-	10	ms	4

- Notes:
1. To avoid spurious start and stop conditions, a minimum delay is placed between SCL = 1 and the falling or rising edge of SDA.
 2. This parameter is sampled.
 3. For a restart condition, or following a WRITE cycle.
 4. The SPD EEPROM WRITE cycle time (t_{WRC}) is the time from a valid stop condition of a write sequence to the end of the EEPROM internal ERASE/PROGRAM cycle. During the WRITE cycle, the EEPROM bus interface circuit is disabled, SDA remains HIGH due to pull-up resistance, and the EEPROM does not respond to its slave address.

Table 14: Serial Presence-Detect Matrix

Byte	Description	Entry (Version)	8GB
0	Number of SPD bytes used by Micron	128	80
1	Total number of bytes in SPD device	256	08
2	Fundamental memory type	DDR2 SDRAM	08
3	Number of row addresses on SDRAM	14	0E
4	Number of column addresses on SDRAM	11	0B
5	DIMM height and module ranks	30mm, quad rank	63
6	Module data width	72	48
7	Reserved	0	00
8	Module voltage interface levels	SSTL 1.8V	05
9	SDRAM cycle time, ^t CK (CL = MAX value, see byte 18)	-667 -53E -40E	30 3D 50
10	SDRAM access from clock, ^t AC (CL = MAX value, see byte 18)	-667 -53E -40E	45 50 60
11	Module configuration type	ECC and parity	06
12	Refresh rate/type	7.81µs/SELF	82
13	SDRAM device width (primary SDRAM)	4	04
14	Error-checking SDRAM data width	4	04
15	Reserved	0	00
16	Burst lengths supported	4, 8	0C
17	Number of banks on SDRAM device	8	08
18	CAS latencies supported	-667 (5, 4, 3) -53E/-40E (4, 3)	38 18
19	Module thickness (with/without heat spreader)	HTS/HTZS	01/04
20	DDR2 DIMM type	Registered DIMM	01
21	SDRAM module attributes	1 PLL, 2 Reg	05
22	SDRAM device attributes: weak driver (01) or weak driver and 50Ω ODT (03)	-667 -53E/-40E	03 01
23	SDRAM cycle time, ^t CK, MAX CL - 1	-667 -53E/-40E	3D 50
24	SDRAM access from CK, ^t AC, MAX CL - 1	-667 -53E -40E	45 50 60
25	SDRAM access from CK, ^t AC, MAX CL - 1	-667 -53E/-40E	50 00
26	SDRAM access from CK, ^t AC, MAX CL - 2	-667 -53E/-40E	45 00
27	MIN row precharge time, ^t RP	-	3C
28	MIN row active-to-row active, ^t RRD	-	1E
29	MIN RAS#-to-CAS# delay, ^t RCD	-	3C
30	MIN active-to-precharge time, ^t RAS	-667/-53E -40E	2D 28
31	Module rank density	2GB	02
32	Address and command setup time, ^t IS _b	-667 -53E -40E	20 25 35

Table 14: Serial Presence-Detect Matrix (continued)

Byte	Description	Entry (Version)	8GB
33	Address and command hold time, t_{IH_b}	-667 -53E -40E	27 37 47
34	Data/data mask input setup time, t_{DS_b}	-667/-53E -40E	10 15
35	Data/data mask input hold time, t_{DH_b}	-667 -53E -40E	17 22 27
36	Write recovery time, t_{WR}	-	3C
37	WRITE-to-READ command delay, t_{WTR}	-667/-53E -40E	1E 28
38	READ-to-PRECHARGE command delay, t_{RTP}	-	1E
39	Memory analysis probe	-	00
40	Extension for bytes 41 and 42	-	00
41	MIN active-to-active/refresh time, t_{RC}^1	-667/-53E -40E	3C 37
42	MIN AUTO REFRESH-to-ACTIVE/AUTO REFRESH command period, t_{RFC}	-	C5
43	SDRAM device MAX cycle time, $t_{CK} (MAX)$	-	80
44	SDRAM device MAX DQS-DQ skew time, t_{DQSQ}	-667 -53E -40E	18 1E 23
45	SDRAM device MAX read data hold skew factor, t_{QHS}	-667 -53E -40E	22 28 2D
46	PLL relock time	-	0F
47-61	Optional features, not supported	-	00
62	SPD revision	Release 1.2	12
63	Checksum for bytes 0-62; (with/without heat spreader; HTS/HTZS)	-667 -53E -40E	22/25 CD/DO 34/37
64	Manufacturer's JEDEC ID code	MICRON	2C
65-71	Manufacturer's JEDEC ID code	(continued)	00
72	Manufacturing location	1-12	01-0C
73-90	Module part number (ASCII)	-	Variable data
91	PCB identification code	1-9	01-09
92	PCB identification code (continued)	0	00
93	Year of manufacture in BCD	-	Variable data
94	Week of manufacture in BCD	-	Variable data
95-98	Module serial number	-	Variable data
99-127	Reserved for manufacturer-specific data	-	00
128-255	Reserved for customer-specific data	-	FF

Notes: 1. The t_{RC} SPD values shown are JEDEC DDR2 device specification values. The actual Micron DDR2 device specification is $t_{RC} = 55ns$ for all speed grades.

Module Dimensions

Figure 3: 240-Pin DDR2 RDIMM

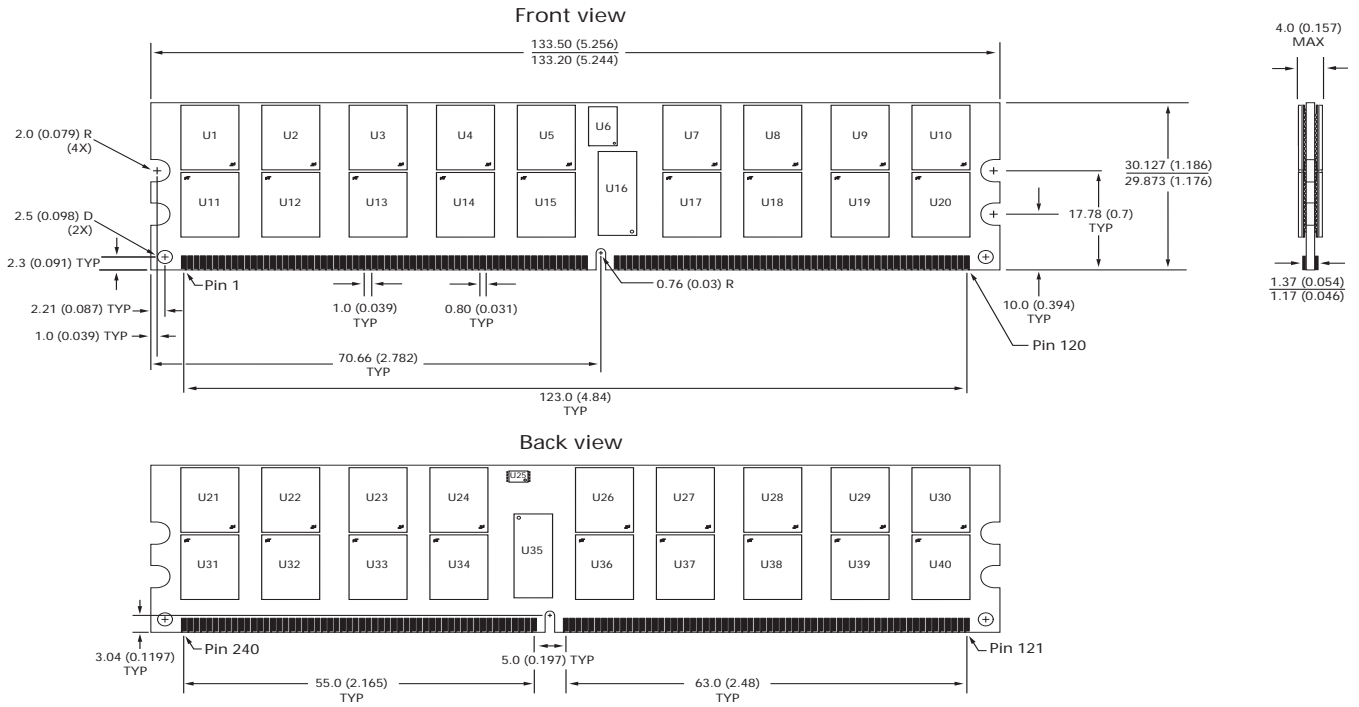

- Notes:
1. All dimensions are in millimeters (inches); MAX/MIN or typical (TYP) where noted.
 2. The dimensional diagram is for reference only. Refer to the JEDEC MO document for additional design dimensions.

Figure 4: 240-Pin DDR2 RDIMM with Heat Spreader

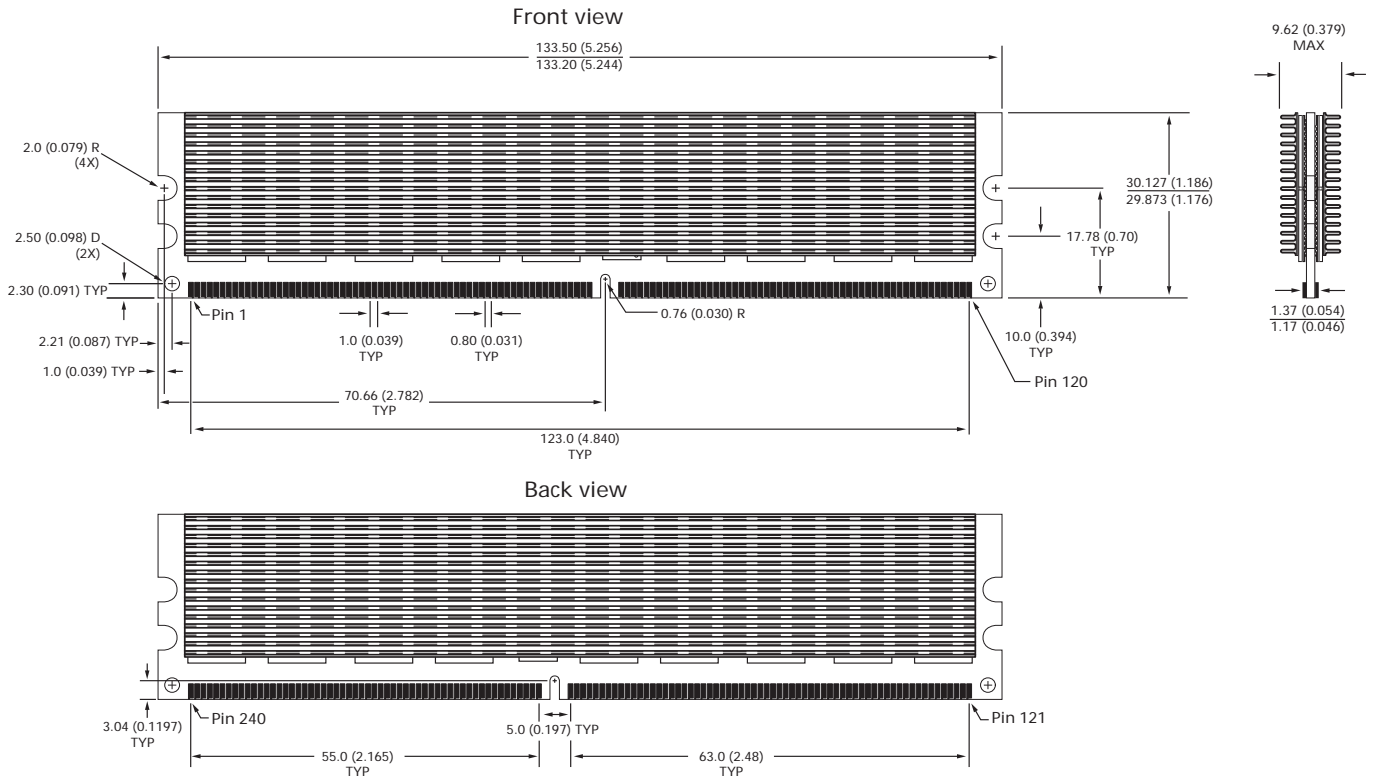

- Notes:
1. All dimensions are in millimeters (inches); MAX/MIN or typical (TYP) where noted.
 2. The dimensional diagram is for reference only. Refer to the JEDEC MO document for additional design dimensions.



8000 S. Federal Way, P.O. Box 6, Boise, ID 83707-0006, Tel: 208-368-3900

prodmktg@micron.com www.micron.com Customer Comment Line: 800-932-4992

Micron, the M logo, the Micron logo, and TwinDie are trademarks of Micron Technology, Inc. All other trademarks are the property of their respective owners.

This data sheet contains minimum and maximum limits specified over the power supply and temperature range set forth herein. Although considered final, these specifications are subject to change, as further product development and data characterization sometimes occur.